

24/7 ASSET MONITORING SOLUTION ENERGY

AMS01 USER MANUAL

SENSeOR (head office)

Bâtiment Natura 2
1198, avenue du Docteur
Maurice Donat
06250 Mougins
France

ISO 9001:2015

BUREAU VERITAS
Certification



Contact address:

support.senseor@wika.com



Regional distributors

Visit www.senseor.com for
the latest distribution
locations.

WARRANTY

These products are warranted to be free from functional defects in material and in workmanship at the time of the manufacturing and to conform at that time to the specifications set forth in the relevant instruction manuals or in the data sheets, for such products for a period of one year.

Reference SENSEOR terms and conditions provided at time of purchase for complete warranty details.



SENSeOR (head office)

Bâtiment Natura 2

1198, avenue du Docteur Maurice Donat,

06250 Mougins

France

SENSeOR reserves the right to make technical changes or to modify the content of this document without prior notice.

SENSeOR is not responsible for errors or for possible lack of information in this document.

All rights reserved. No part of this document may be reproduced, distributed, or transmitted in any form or by any means, including photocopying, recording, or other electronic or mechanical methods, without the prior written permission of SENSEOR, except in the case of brief quotations embodied in critical reviews and certain other non-commercial uses permitted by copyright law.

Copyright © 2024, SENSEOR

TABLE OF CONTENTS

WARRANTY	2
TABLE OF CONTENTS	3
SAFETY INSTRUCTIONS	5
1.0 CONVENTIONS.....	5
1.1 SAFETY INFORMATIONS.....	6
TECHNICAL SPECIFICATIONS	7
1.0 RELATED DOCUMENTS	8
1.1 AVAILABLE PRODUCTS	8
1.2 INSTRUCTIONS FOR USE	9
1.3 READER OVERVIEW	10
1.3.1 SERIALIZATION LABEL.....	10
1.3.2 FRONT LABELS.....	10
1.4 CONNECTORS & FUNCTIONS	11
1.4.1 INPUT POWER (1)	11
1.4.2 ENVIRONMENTAL SENSOR (2)	11
1.4.3 RF ANTENNAS (3).....	12
1.4.4 ETHERNET PORT (4)	12
1.4.5 SD CARD (5).....	13
1.4.6 RS485 PORTS (6)	13
1.4.7 USB PORT (7).....	13
1.4.8 RELAY OUTPUT (8)	14
1.4.9 LEDS INTERFACE (9)	15
1.5 STATUS LEDES	15
1.5.1 DFU MODE LEDES INDICATION (DEVICE FIRMWARE UPGRADE).....	15
1.5.2 APPLICATIVE MODE LEDES INDICATION	16
INSTALLATION	17
1.6 UNPACKING	18
1.6.1 PHYSICAL DIMENSIONS.....	18
1.7 DIN RAIL MOUNTING.....	19
1.7.1 READER EMBLACEMENT	20
1.7.2 RECOMMENDED SPACING	20
WIRING	21
1.8 POWER.....	21
1.8.1 INPUT POWER.....	21

- 1.8.2 RELAY OUTPUT 22
- 1.8.3 INTERNAL BATTERY 22
- 1.9 COMMUNICATION CONNECTIONS 23
 - 1.9.1 CABLING FOR RS485 COMMUNICATION 23
 - 1.9.2 BUS RESISTIVE TERMINATION 23
 - 1.9.3 BUS DATA RATE 24
 - 1.9.4 BUS LENGTH..... 24
 - 1.9.5 NUMBER OF READERS 24
 - 1.9.6 MODBUS-RTU DEFAULT CONFIGURATION 24
 - 1.9.7 CABLING FOR ETHERNET COMMUNICATION..... 25
- 1.10 ENVIRONMENTAL SENSOR CONNECTION 25
- 1.11 CONNECTING TO EARTH 26
- 1.12 CONNECTING RF ANTENNAS 26
 - 1.12.1 ANTENNA POSITIONING 27
- SYSTEM INSTALLATION AND CONFIGURATION..... 28
 - 1.13 SAW TEMPERATURE SENSORS INSTALLATION 28
 - 1.14 SYSTEM CONFIGURATION..... 28
 - 1.15 DFU & NETWORK PARAMETERS RESET 28
 - 1.15.1 DFU MODE..... 28
 - 1.15.2 NETWORK PARAMETERS RESET 29
 - 1.16 SD CARD..... 30
- CERTIFICATIONS..... 31
 - 1.17 CERTIFICATIONS..... 31



SAFETY INSTRUCTIONS

IT IS IMPORTANT TO READ THIS MANUAL BEFORE INSTALLING OR COMMISSIONING SENSEOR ASSETS MONITORING SYSTEM.

1.0 CONVENTIONS

DANGER

DANGER INDICATES AN IMMINENTLY HAZARDOUS SITUATION, WHICH, IF NOT AVOIDED, WILL RESULT IN DEATH OR SERIOUS INJURY.

FAILURE TO FOLLOW THE INSTRUCTIONS GIVEN WILL RESULT IN DEATH OR SERIOUS INJURY.

WARNING

WARNING INDICATES A POTENTIALLY HAZARDOUS SITUATION, WHICH, IF NOT AVOIDED, COULD RESULT IN DEATH OR SERIOUS INJURY.

FAILURE TO FOLLOW THE GIVEN INSTRUCTIONS CAN RESULT IN DEATH OR IN SERIOUS INJURY.

CAUTION

CAUTION INDICATES A POTENTIALLY HAZARDOUS SITUATION, WHICH, IF NOT AVOIDED, MAY RESULT IN MINOR OR MODERATE INJURY.

FAILURE TO FOLLOW THESE INSTRUCTIONS CAN RESULT IN PERSONAL INJURY.

NOTICE

NOTICE PROVIDES GUIDANCE ON DAMAGE UNRELATED TO PERSONAL INJURY, SUCH AS THOSE THAT CAN CAUSE DETERIORATED PROPERTY.

FAILURE TO FOLLOW THESE INSTRUCTIONS CAN RESULT IN PROPERTY DAMAGE.

IMPORTANT

IMPORTANT INDICATES ADDITIONAL INFORMATION ABOUT MAKING EFFECTIVE USE OF THIS PRODUCT.

1.1 SAFETY INFORMATION

- ▶ The system is intended for indoor use only.
- ▶ Protect system from moisture and humidity.
- ▶ Protect system from too high or too low temperature.
- ▶ Protect system from fire.
- ▶ Do not paint the system elements.
- ▶ Do not modify or disassemble the system elements. Service must be carried out by *SENSeOR*.
- ▶ Store system elements in dry and dust-free place.

TECHNICAL SPECIFICATIONS

The reader is a professional equipment designed to perform temperature measurement and partial discharge detection into switchgear cabinets.

The following main specifications are applicable to this product :

RS485 INTERFACE	
Protocol	Modbus-RTU
Supported baud rates	9 600, 19 200, 38 400, 57 600 & 115 200 bauds

ETHERNET INTERFACE	
Protocols	Modbus-TCP, <i>SENSeOR</i> proprietary for configuration
Speed	10/100 Mbps

RELAY OUTPUT	
Number of configurable channels	1
Type	Normally Open contact
Operating power	30VDC / 250VAC, 2A max. – OVC II

ELECTRICALS & PHYSICALS	
Operating power	24VDC ($\pm 10\%$) < 200 mA – required an isolated supply
Dimensions	150 x 150 x 44 mm – without DIN fixation
Weight	270 g
Operating conditions	From 10 to 95%rH non-condensing From -20 to +45°C
Ingress protection code	IP40 (indoor use only)
Pollution degree index	2
Enclosure	Black anodized aluminium
Fixation mode	35 mm DIN rail

CAUTION

THIS READER IS DEDICATED TO SWITCHGEAR MONITORING WITH WIRELESS PASSIVE SAW TEMPERATURE SENSORS, ENVIRONMENTAL SENSOR, AND UHF PARTIAL DISCHARGE DETECTION. IT IS DESIGNED FOR USE INSIDE METALLIC CAVITIES ONLY LIKE THE SWITCHGEAR CABINET AND TUNED TO BE COMPLIANT WITH IEC 62271 ENABLING A LICENSE-FREE USE IN SWITCHGEAR WORLDWIDE.

1.0 RELATED DOCUMENTS

- UM00400-EN: AMS01 Configuration Tool User Manual.
- UM00417-EN: AMS01 Modbus table.
- UM00418-EN: AMS01 Modbus table with HTR02 compatibility mode.
- UM00419-EN: AMS01 SD card file management.
- SD00385-EN: AMS01 readers Datasheet.

For additional related documentation and file downloads see support website at senseor.com/downloads.

1.1 AVAILABLE PRODUCTS

This manual covers the following products:

- **AMS01-T**: Temperature monitoring only.
- **AMS01-P**: Partial discharge monitoring only.
- **AMS01-TP**: Temperature & partial discharge monitoring.

1.2 INSTRUCTIONS FOR USE

The AMS01 reader is dedicated to monitor electrical equipment like switchgears. The temperature of live conductors is measured by SAW sensors and prevent overheating and overload. Partial discharges are measured by antenna pairs and prevent equipment failure. Ambient temperature and humidity measurements are also available through an optional [environmental sensor](#) connected with wires to the reader.

The reader is intended to be installed in low voltage compartments of switchgear or in similar type of assets. It can also be installed in a weatherproof environmental enclosure.

The reader is intended for use at a maximum altitude of *5 km*, typically between -20°C to $+70^{\circ}\text{C}$ (refer to reader specification for the complete specification) and between *10%* to *95%* non-condensing relative humidity.

WARNING

THE READER IS NOT INTENDED FOR INSTALLATION INTO MEDIUM OR HIGH VOLTAGE COMPARTMENT ASSETS. ONLY SAW TEMPERATURE SENSORS, ENVIRONMENTAL SENSOR AND RF ANTENNAS ARE INTENDED FOR INSTALLATION INTO MEDIUM VOLTAGE COMPARTMENTS.

1.3 READER OVERVIEW

Included in scope of delivery:

- 1x AMS01 reader.
- 1x AMS01 system user manual.
- 1x μ SD card.
- 1x 2-pin power connector.
- 1x 4-pin environmental sensor connector.
- 1x 2-pin relay connector.
- 1x 35 mm DIN rail mount with 2x M3x6 mm screws.

1.3.1 SERIALIZATION LABEL



Figure 1: Product serialization label

1.3.2 FRONT LABELS

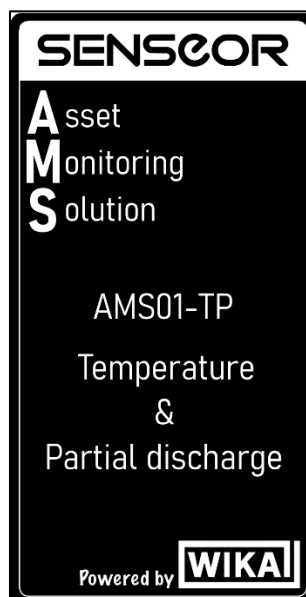

Figure 2: Example of front product labels

1.4 CONNECTORS & FUNCTIONS

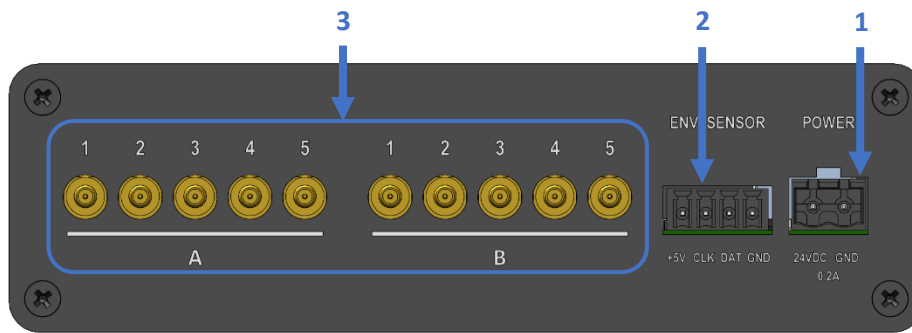

Figure 3: Rear connection view

1.4.1 INPUT POWER (1)

Pin	Type	Description
1 (left)	+24VDC	Main power supply input (24VDC 0.2A)
2 (right)	GND	Ground

CAUTION

DO NOT REVERSE THE POWER SUPPLY POLARITY, THIS MAY CAUSE ELECTRICAL DAMAGE.

1.4.2 ENVIRONMENTAL SENSOR (2)

Pin	Type	Description
1 (left)	+5VDC	Power supply of environmental sensor (5V out from reader)
2	CLK	Clock
3	DAT	Data
4 (right)	GND	Ground

CAUTION

CONNECT ENVIRONMENTAL SENSOR ONLY.

1.4.3 RF ANTENNAS (3)

Connector	Type	Description
1A (left)	RF	Antenna 1A
2A		Antenna 2A
3A		Antenna 3A
4A		Antenna 4A
5A		Antenna 5A
1B		Antenna 1B
2B		Antenna 2B
3B		Antenna 3B
4B		Antenna 4B
5B (right)		Antenna 5B

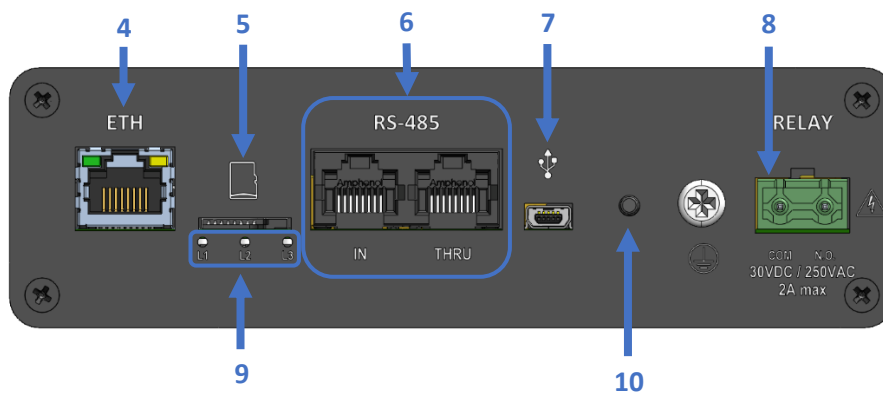

Figure 4: Front connection view

1.4.4 ETHERNET PORT (4)

Standard RJ45 socket for Modbus-TCP communication and reader configuration.

Pin	Type	Description
1	Tx +	Transmit data +
2	Tx -	Transmit data -
3	Rx +	Receive data +
4	-	Not used
5	-	Not used
6	Rx -	Receive data -
7	-	Not used
8	-	Not used

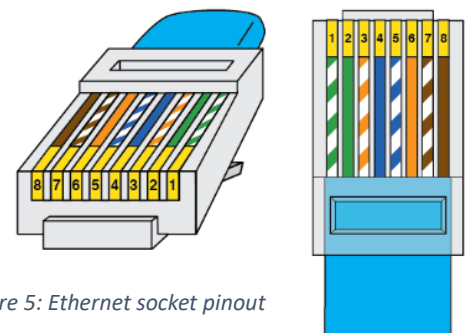

Figure 5: Ethernet socket pinout

1.4.5 SD CARD (5)

Memory card slot for μ SD cards.

Specification	Form factor	File system	Bus interface	Speed class	Others
Version 3.0.1 (2010)	MicroSD HC	FAT32	UHS-I	Class 10	SD Smart

1.4.6 RS485 PORTS (6)

RJ45 ports for Modbus-RTU communication.

Pin	Type	Description
1 (left)	-	Not used
2	-	Not used
3	-	Not used
4	A	Data +
5	B	Data -
6	-	Not used
7	-	Not used
8 (right)	GND	Ground



Figure 6: RS485 socket pinout

1.4.7 USB PORT (7)

Mini USB port not used.

CAUTION

DO NOT CONNECT ANYTHING.

1.4.8 RELAY OUTPUT (8)

Pin	Type	Description
1 (left)	COM	Common for relay
2 (right)	Normally Open (N.O.)	Alarm relay activation (30VDC / 250VAC, 2A max. – OVC2)

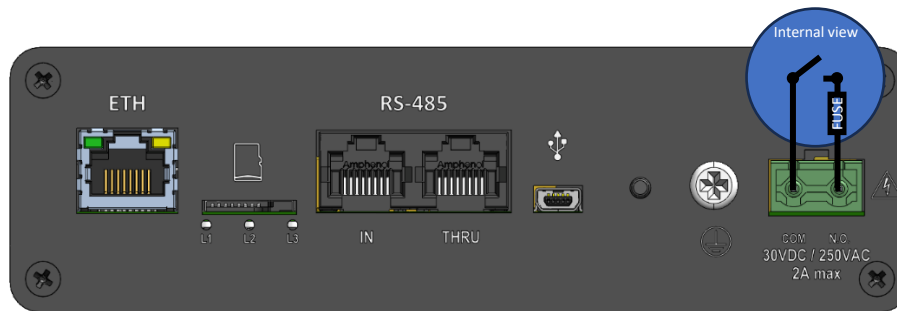

Figure 7: Relay output cabling

CAUTION



THE TERMINALS OF CONNECTOR ARE NON-INSULATED. THE ELECTRICAL VOLTAGE THAT CAN BE APPLIED (UP TO 250VAC) REPRESENTS A DANGER OF ELECTRICAL SHOCK AND MUST BE CARRIED OUT WITHOUT POWER.

1.4.9 LEDS INTERFACE (9)

Status LEDs.













1.5 STATUS LEDS

Status LEDs are used to indicate the functional state of reader.

1.5.1 DFU MODE LEDS INDICATION (DEVICE FIRMWARE UPGRADE)





DFU is an AMS01 internal recovery/update program mode automatically called during firmware update process.

Following table indicates reader status in this mode.





Description	LED1 status (L1)	LED2 status (L2)	LED3 status (L3)
No power <i>LEDs OFF</i>			
DFU mode <i>LEDs blinking</i>			
<i>Manually entered</i>			
<i>Corrupted firmware detected</i>			
Firmware update in progress <i>LEDs blinking</i>			

1.5.2 APPLICATIVE MODE LEDS INDICATION

1.5.2.1 LED 1 (L1) indication description

Description	Status
No power <i>LED OFF</i>	
System is working properly <i>LED ON</i>	
System warning <i>LED ON</i>	
System error <i>LED ON</i>	

1.5.2.2 LED 2 (L2) indication description

Description	Status
No notifier configured <i>LED OFF</i>	
At least one notifier configured <i>LED ON</i>	
At least one notifier in temperature warning or PD medium level state <i>LED ON</i>	
At least one notifier in temperature alarm or PD high level state <i>LED ON</i>	

1.5.2.3 LED 3 (L3) indication description

Reserved for future use.

INSTALLATION

IMPORTANT

THE INSTALLATION INSTRUCTIONS ARE ONLY FOR THE AMS01 READER.

IT IS ASSUMED THAT SAW TEMPERATURE SENSORS AND PARTIAL DISCHARGE PROBE ANTENNAS HAVE BEEN CONFIGURED AND INSTALLED.

WARNING

PROFESSIONAL INSTALLATION REQUIRED.

INSTALLATION AND CONFIGURATION SHOULD BE PERFORMED ONLY BY USERS WHO ARE TECHNICALLY COMPETENT AND AUTHORIZED TO DO SO.

LOCAL REGULATIONS REGARDING ELECTRICAL INSTALLATION AND SAFETY MUST BE OBSERVED.

FAILURE TO FOLLOW THE GIVEN INSTRUCTIONS CAN RESULT IN DEATH OR IN SERIOUS INJURY.

WARNING

THE USE OF THIS EQUIPMENT IN A MANNER NOT SPECIFIED IN THIS MANUAL OR BY THE MANUFACTURER MAY IMPAIR PROTECTION OF THE USER AND EQUIPMENT.

CAUTION

THIS EQUIPMENT IS DESIGNED FOR INSTALLATION IN AN ENCLOSURE THAT PROVIDES ADEQUATE PROTECTION AGAINST ELECTRICAL SHOCK.

1.6 UNPACKING

1.6.1 PHYSICAL DIMENSIONS

Unit in mm.

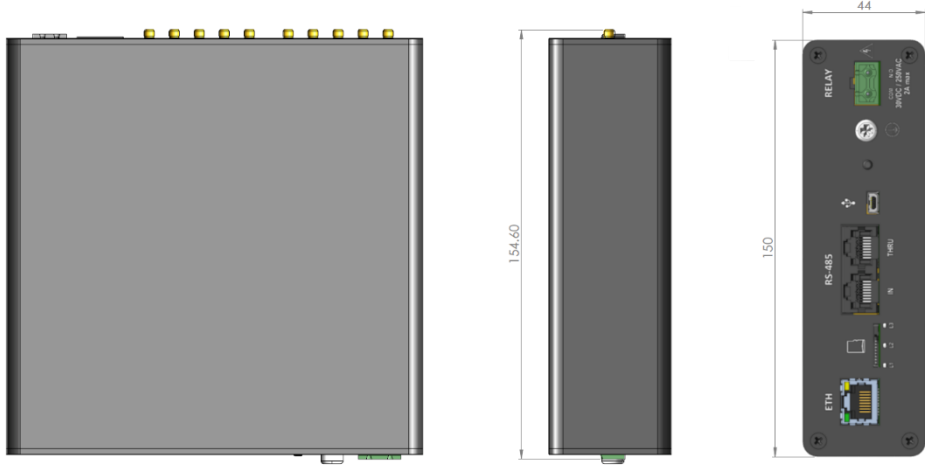

Figure 8: Reader dimensions views

1.7 DIN RAIL MOUNTING

CAUTION

ENSURE THAT THE LOW-LEVEL COMPARTMENT WHERE THE READER IS MOUNTED IS SUFFICIENTLY VENTILATED TO PREVENT OVERHEATING. THE DEVICE MUST BE ELECTRICALLY GROUNDED FOR EMC COMPLIANCE.

The reader is designed for installation on a grounded 35 mm DIN rail. It could be mounted in two different positions to facilitate integration.

Using the fixing clip and the two screws provided, screw it onto the box enclosure according to the preferred orientation.

SENSeOR recommends mounting the device vertically with antennas output to the top.

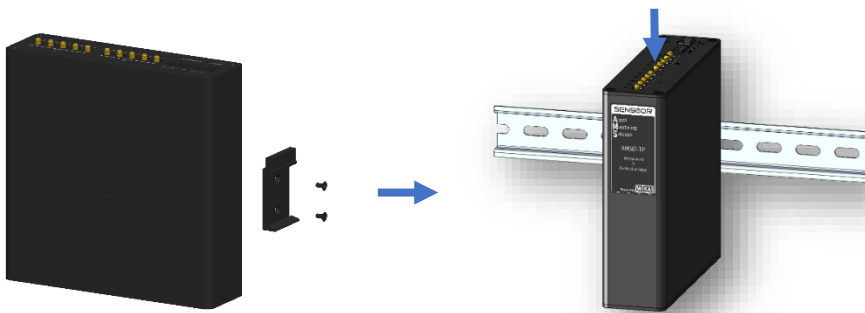

Figure 9: DIN rail fixation – Configuration 1



Figure 10: DIN rail fixation – Configuration 2

1.7.1 READER EMPLACEMENT

The reader is intended to be installed in the low voltage compartment of the switchgear. The other electrical assets are recommended to be weather protected in an enclosed location.

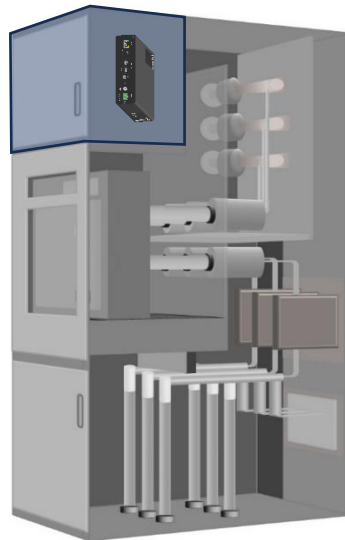

Figure 11: Reader emplacement in switchgear

The reader is required to be installed within a maximum distance of *10 meters* from the antennas, corresponding to the maximum length of the antenna coaxial cable for SAW temperature sensors and partial discharge measurement.

1.7.2 RECOMMENDED SPACING

For connectors access, it is recommended to leave the minimum clearance for top and bottom panels of *5 cm (2 inches)*.

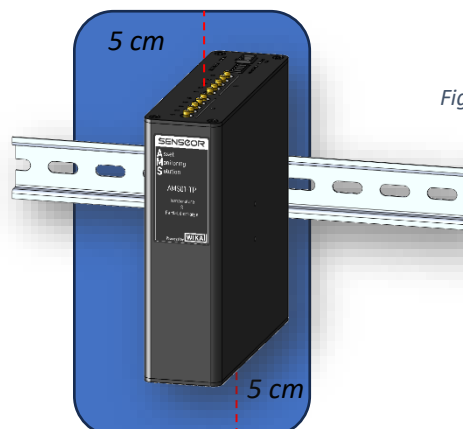

Figure 12: Reader access clearance

WIRING

1.8 POWER

The reader power connector is a 2-pin male connector. This screw connector supports from 26 to 16 AWG wires (0.13 to 1.31 mm² section). For stranded conductor use connector ferrules on the termination.

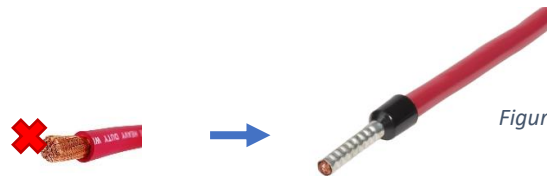

Figure 13: Connector ferrule

1.8.1 INPUT POWER

The reader operates at 24VDC nominal with a total power consumption of 6 Watts maximum.

SENSeOR recommends the use of a **DC power supply** in the same low-voltage compartment as the reader. It is possible to run a DC power bus to power multiple readers from one DC power supply. However, this option requires a careful consideration of the wire diameter, AC/DC, and circuit breaker capabilities.

Power connections are recommended to be at a minimum of 16 AWG (1.31 mm² section).

If bussed power is being considered, the wire gauge must be selected to prevent excessive voltage drop between the DC power source and the reader that is electrically farthest from the source.

The following block diagram outlines the recommended power wiring for the reader with a 2-pole circuit breaker and an AC/DC power supply. Surge suppression devices can also be installed between the input line and the neutral only if higher safety rating is required.

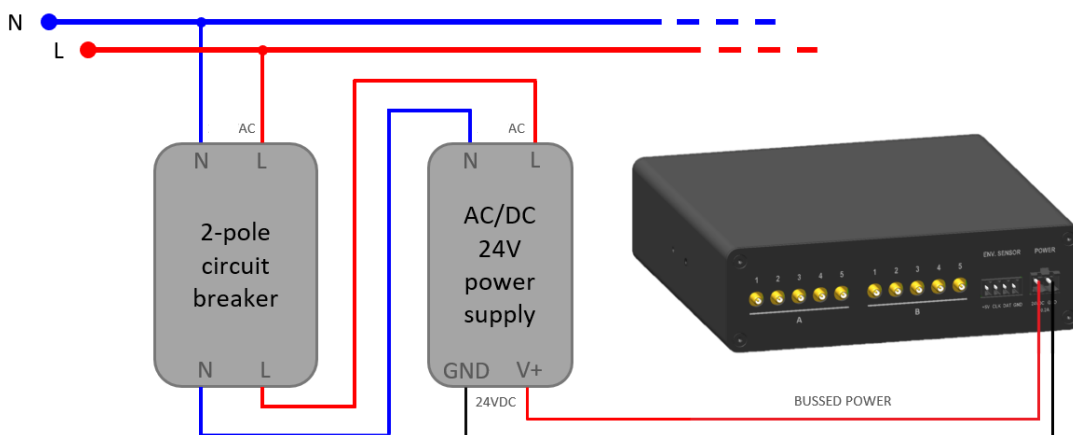

Figure 14: Reader power cabling

1.8.2 RELAY OUTPUT

Output relay connections are recommended to be at 18 AWG (0.82 mm² section) to cover the entire voltage range.

1.8.3 INTERNAL BATTERY

SENSeOR reader has an internal 3VDC non rechargeable battery to keep the UTC date and the time in case of power down. Battery needs to be replaced if voltage value is under **2.1V**.

It can be replaced only by authorized person using the following or an equivalent reference:



Figure 15: 3V Lithium CR2032 battery

1.8.3.1 Battery replacement procedure

- ▶ Disconnect all the AMS01 reader connections (antennas, environmental sensor, relay, and power supply).
- ▶ Using a PZ1 screwdriver, disconnect the ground lug and remove the screw.
- ▶ Extract the reader from its location on the DIN rail.
- ▶ Remove the 4 screws from the front panel.
- ▶ Remove the electronic card from the enclosure.
- ▶ Identify and replace the CR2032 battery **by carefully respecting its polarity**.
- ▶ Reinsert the electronic card in the enclosure.
- ▶ Screw the front panel on the enclosure.
- ▶ Reposition the reader on its location on the DIN rail.
- ▶ Reconnect the ground lug with the corresponding screw.
- ▶ Reconnect all the AMS01 reader connections (antennas, environmental sensor, relay, and power supply).

WARNING

THERE IS A RISK OF EXPLOSION IF THE BATTERY IS REPLACED BY AN INCORRECT TYPE.
BE CAREFUL OF USED BATTERY IN ACCORDANCE WITH YOUR REGIONAL LEGAL INSTRUCTIONS.

1.9 COMMUNICATION CONNECTIONS

The components are used to connect Modbus devices, energy communication systems and industrial equipment with each other and to SCADA or cloud systems.

The reader could be connected to a network using RS485 Modbus-RTU or Ethernet Modbus-TCP.

1.9.1 CABLING FOR RS485 COMMUNICATION

SENSeOR recommends the use of shielded cable for the RS485 wiring, providing at least one twisted pair, one single line, and a drain wire. Although, a typical recommended cable has two twisted pair. The twisted pair provides *DATA ±* signals to each reader while the single line would be for *D-COM*, providing a low-impedance return for each reader.



Figure 16: RS485 daisy chaining

1.9.2 BUS RESISTIVE TERMINATION

The RS485 bus needs to be terminated at each end with a *120 Ohms* resistor when long stretches of cable are used. This ensures that the bus has the correct impedance.

However, if the bus length is less than 2% of its maximum (20 meters at 9 600 bauds), the termination resistor may be omitted.

In general, RS485 adapters and master bus provide the source impedance internally and should be located at one end of the bus. If not, use this pinout to cable the resistor.

Pin	Type	Description
1 (left)	-	<i>Not used</i>
2	-	<i>Not used</i>
3	-	<i>Not used</i>
4	120 Ohms	Resistance pin 1
5	120 Ohms	Resistance pin 2
6	-	<i>Not used</i>
7	-	<i>Not used</i>
8 (right)	-	<i>Not used</i>

1.9.3 BUS DATA RATE

The RS485 bus data rate is dependent on the bus cable length and the number of readers on the bus. In industrial environments, slower data communication rates are generally more reliable.

1.9.4 BUS LENGTH

Bus cable length has an impact on the overall data rates that can be achieved. A conservative rule for RS485 follows this equation:

$$\text{Baud rate} \times \text{cable length (m)} < 10 \times 10^6$$

A 9 600 bauds network would require a bus length less than $(10 \times 10^6 / 9\,600)$ equals to 1 042 meters (about 3 400 feet). This is perfectly adequate for most substation installations.

1.9.5 NUMBER OF READERS

The more readers on the RS485 bus there are, the weaker the baud rate is. Baud rate must be adjusted to accommodate the electrical characteristics depending on the circuit.

The following table provides an example of recommended baud rate following the number of readers:

Number of readers	Recommended baud rate
1	115 200
2	38 400
3	19 200
From 4 to 15	9 600

SENSeOR recommends connecting a maximum of 15 readers on a RS485 bus.

1.9.6 MODBUS-RTU DEFAULT CONFIGURATION

By default, the reader is configured with the following settings:

- Baud rate: **19 200**
- Data bits: **8**
- Parity: **None**
- Stop bits: **1**

1.9.7 CABLING FOR ETHERNET COMMUNICATION

SENSeOR recommends the use of shielded *Cat 5e SFTP* cable for the Ethernet wiring.

Readers Ethernet network is provided by a fixed configuration more detailed below.

The IP address is defined by the last four digits of the product serial number printed on the side of the reader.

Serial number: Q2A123457890

IP address: 10.200.78.90

The connected computer must have an IP address in the range of '10.200.AA.BB' subnet and with '255.255.0.0' mask. To avoid any IP addresses conflict between the reader and the computer, 'AA' and 'BB' settings are recommended to be higher or to be equal to the value of '100'.

IMPORTANT

IN CASE OF COMMUNICATION TROUBLES WITH THE '*AMS01 CONFIGURATION TOOL*' APPLICATION, CHECK THAT THE FOLLOWING COMMUNICATION PORTS ARE OPENED ON THE COMPUTER: '6560', '5707', '5709' & '5710'.

1.10 ENVIRONMENTAL SENSOR CONNECTION

The *SENSeOR* environmental sensor provides humidity, ambient temperature and dew point measurements recommended to complement the partial discharges data. Connection of this environmental sensor must be done respecting cable colors and connector position.

Use 4-conductor 24 AWG (0.20 mm² section) shielded cable with 6-meter maximum length.

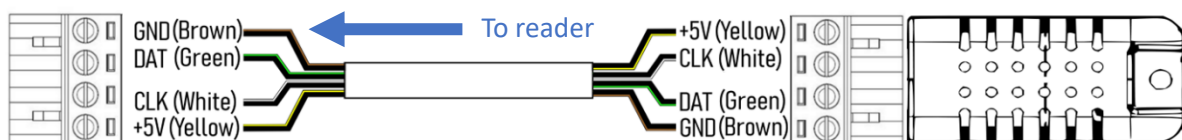

Figure 17: '*EXT-ENV-SENS*' environmental sensor cabling

1.11 CONNECTING TO EARTH

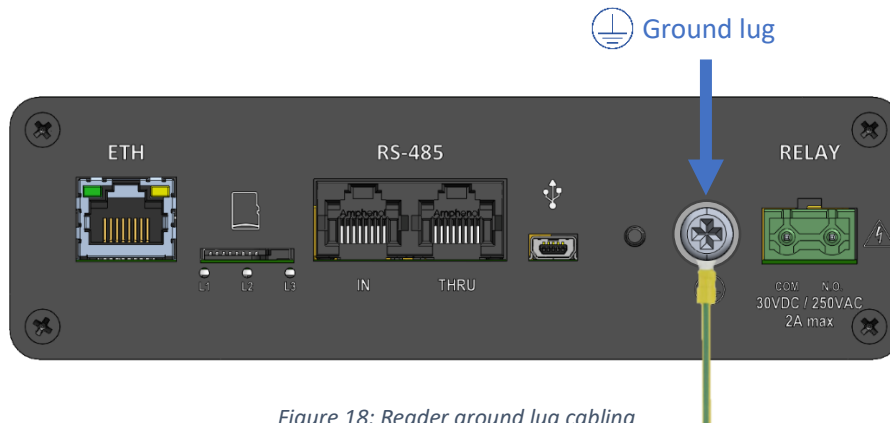

Figure 18: Reader ground lug cabling

Earth connections must be done using ground lug with a minimum of 16 AWG (1.31 mm² section) with ring terminal.

IMPORTANT

THE EARTH TERMINAL MUST BE PLACED BETWEEN THE NOTCHED WASHER AND THE SCREW HEAD.

1.12 CONNECTING RF ANTENNAS

Antenna installation should respect following pattern. Two antennas by compartment connected to the reader using A and B output connectors.

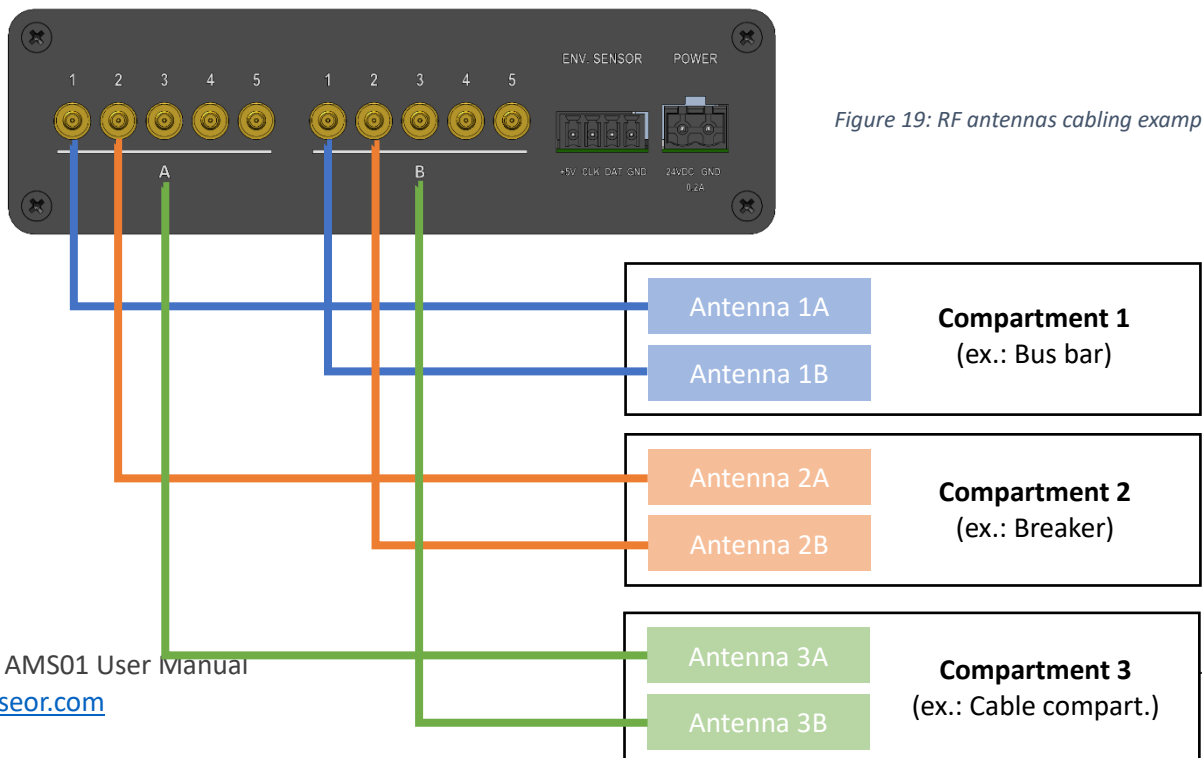

Figure 19: RF antennas cabling example

1.12.1 ANTENNA POSITIONING

- ▶ Space antennas environment for at least 10 cm of metallic parts:

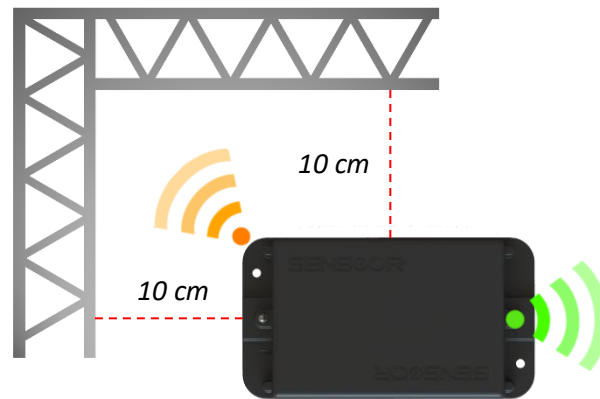

Figure 20: Antenna environment

- ▶ Place antennas of the same pair ('A' & 'B') on each side of the installed sensors:

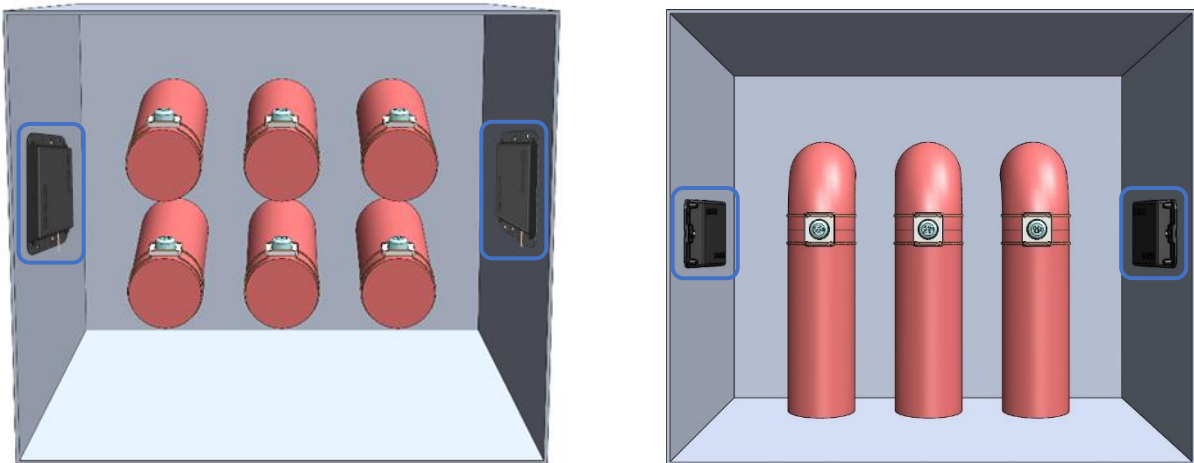

Figure 21: Antennas positioning

- ▶ Align the antennas collinearly along the largest metal surface.
- ▶ The magnets used to attach the antennas must all be in direct contact with the metal surface:



Figure 22: Antenna fixing

SYSTEM INSTALLATION AND CONFIGURATION

1.13 SAW TEMPERATURE SENSORS INSTALLATION

This manual does not cover all specific SAW temperature sensors installation.

1.14 SYSTEM CONFIGURATION

The reader requires a system configuration for the associated installed SAW temperature sensors, the ambient humidity and temperature sensors and the partial discharge probe antennas.

The configuration is performed through the Ethernet network interface and uses the 'AMS01 Configuration Tool' application.

For configuration details, see the ['AMS01 Configuration Tool User Manual'](#) for detailed instructions.

1.15 DFU & NETWORK PARAMETERS RESET

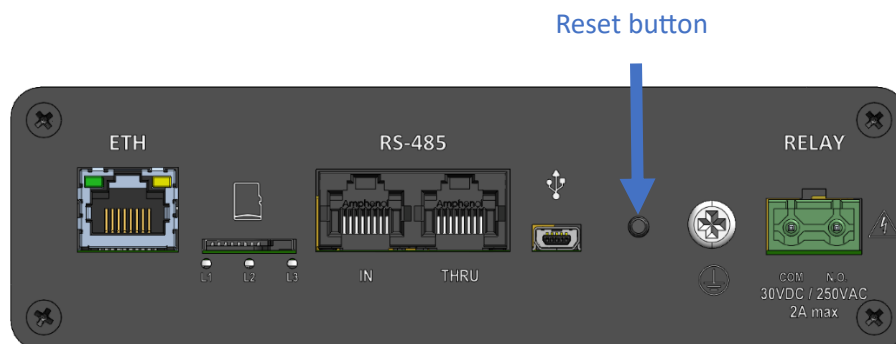

Figure 23: Reset button on front face

1.15.1 DFU MODE

In case of necessity, following procedure will switch the product in DFU mode:

- ▶ Disconnect the device from power supply.
- ▶ Press and hold the *Reset* button.
- ▶ While holding the *Reset* button, connect the device to power supply.
- ▶ Hold the *Reset* button until LEDs are flashing with following pattern: 'L1' green and 'L2', 'L3' red. This can take up to 5 seconds.
- ▶ Release the *Reset* button.

1.15.2 NETWORK PARAMETERS RESET

IMPORTANT

ONLY ETHERNET SETTINGS ARE LOST (BACK TO DEFAULT VALUES) WHEN DEVICE IS RESET.

- ▶ Hold the *Reset* button until all LEDs are flashing green. This can take up to 15 seconds.
- ▶ Release the *Reset* button.
- ▶ Wait until the device is started up. **Do not disconnect power supply before the device is started up.**

1.16 SD CARD

A μ SD HC memory card is inserted into the reader and will save all measurements locally.

Please refer to the document 'UM00419EN-AA_AMS01 SD card file management' for more information about the files and data format.

SENSeOR recommends using an 8 Gb μ SD card capacity to store enough data.

CERTIFICATIONS

1.17 CERTIFICATIONS

RoHS 2011/65/EU and 2015/863/EU

IEC 62271-1: Switchgear, CISPR11

IEC 61000-4-2, IEC 61000-4-4, IEC 61000-4-17

IEC 61000-4-18, IEC 61000-4-29

IEC 60068-2-1, IEC 60068-2-2, IEC 60068-2-6, IEC 60068-2-30

IEC 60068-2-6, IEC 60068-2-78

IEC 60255-21-1, IEC 60255-21-3

IEC 61010-1 (from hardware version 'AF')

